

MIPRO[®]

MICROPHONE PROFESSIONALS

ACT-70T/ACT-52T/ACT-32T/

ACT-24T/ACT-58T

Two AA Disposable Batteries

ACT-70TC/ACT-52TC/ACT-32TC/

ACT-24TC/ACT-58TC

Rechargeable Lithium Battery

Bodypack Transmitters User Guide



ACT-70T ACT-52T ACT-32T ACT-24T ACT-58T



ACT-70TC ACT-52TC ACT-24TC ACT-58TC
ACT-32TC

I. Parts Name

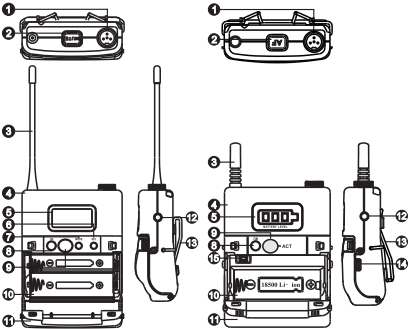

AA Battery (left); Rechargeable Battery (right)

- ❶ 4-Pin Microphone Input Jack
- ❷ Mute button
- ❸ Transmitting Antenna
- ❹ Housing
- ❺ LCD Panel
- ❻ SET button
- ❼ MODE button
- ❽ Power Switch
- ❾ ACT Sync Window
- ❿ Battery Compartment
- ⓫ Battery Cover
- ⓬ Remote control mute connector
- ⓭ Reversible Belt Clip
- ⓮ Battery Charging Contact (Rechargeable)

- ⑮ Battery protection circuit reset button
(ACT-70TC/ACT-52TC/ACT-32TC
Rechargeable)

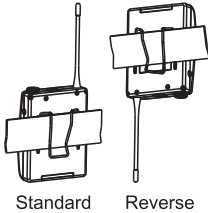

II. 4-Pin Microphone Input Jack Connection

1. Before turning on the power, connect the input signal source to the microphone input jacket ① first to avoid open-circuit induced noise.
2. Align and fasten the connector clockwise for a secured fit.

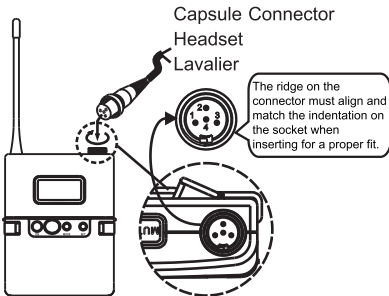

III. Operating Instructions

ACT-24T/ACT-24TC/ACT-58T/ACT-58TC:

1. Power On/Off: Press & hold the power button for two seconds to power on or power off the device. The LED lights on after the device is powered on.

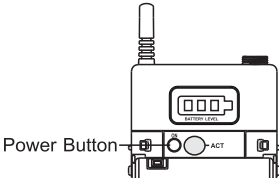

2. Battery level indicators: Recommend charging when single red indicator remains. Power shutdown automatically when battery voltage is too low.

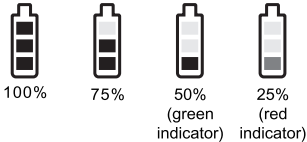

ACT-70T/ACT-70TC/ACT-52T/ACT-52TC/ ACT-32T/ACT-32TC :

1. Power On/Off:

- (A) Press and hold the power button for two seconds to power on or power off the device.

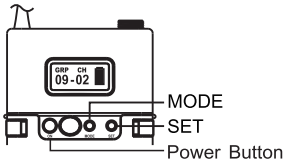

- (B) The LCD screen display OFF... during powering off.



2. Battery level indicators: Recommend charging once level falls to 10% and the screen flashes. Device will power off automatically with an OFF message once power level falls too low.

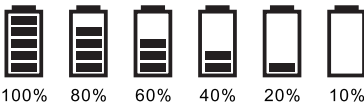

3. LCD Screen:



4. Press MODE button 7 to access all the functions.
5. Press SET button 6 once to denote a change. Existing parameter starts flashing. Press SET button second time to change the programmed parameters.

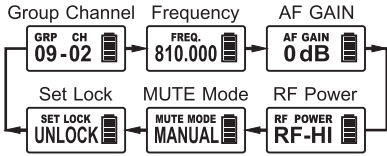

6. Group (GRP) / Channel (CH) / Frequency (FREQ.) are synced from receiver and cannot be changed.



7. AF Gain Setting:

- (A) AF Gain can be changed from 12dB ~ -12dB, in 6dB steps.
- (B) Press MODE button to access AF GAIN parameter. Press SET button to change. To save, press MODE button or until flashing stops.
- (C) The higher the AF gain is, the lower the input signal of dynamic range will be and it will increase noise and feedback chances.
- (D) Set AF Gain to -12dB for guitar.
- (E) 0dB is the factory default setting.

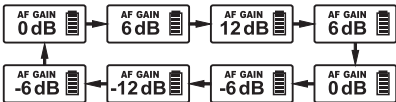

8. RF Power Setting:

- (A) RF Power can be changed to RF-HI or RF-LOW.
- (B) Press MODE button to access RF POWER parameter. Press SET button, the parameters start flashing. Press SET button again, the parameter will change circularly. Press MODE button to save or the parameter saves automatically when flashing stops.



9. MUTE MODE Setting:

- (A) MUTE MODE can be changed to MANUAL or DISABLE.
- (B) Press MODE button to access MUTE MODE parameter. Press SET button, the parameters start flashing. Press SET button again, the parameter will change circularly. Press MODE button to save or the parameter saves automatically when flashing stops.
- (C) MANUAL mode indicates MUTE button can be muted.
- (D) DISABLE mode indicates MUTE button cannot be muted.



10. Lock Setting:

- (A) LOCK can be changed to LOCK or UNLOCK.
- (B) Press MODE button to access LOCK parameter. Press SET button, the parameters start flashing. Press SET button again, the parameter will change circularly. Press MODE button to save or the parameter saves automatically when flashing stops.
- (C) LOCKED mode indicates all the parameters cannot be changed and power button cannot work. Press SET button and the screen displays LOCKED.
- (D) Repeat same procedures to change back to UNLOCK mode. UNLOCK mode indicates power is operational and the parameters can be changed.

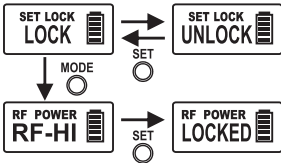

11. Error codes:

- (A) ERR no01→Channel wasn't programmed or internal data error.
- (B) ERR no02→Testing only.
- (C) ERR no03→The set frequency exceeds the upper band. The microphone frequency will not be changed but it can be operated as long as the power switch is turned on again.
- (D) ERR no04→The set frequency exceeds the lower band. The microphone frequency will not be changed but it can be operated as long as the power switch is turned on again.

12. GROUP CHANNEL are internal programmed channels.

13. CHANNEL displays only (GROUP is not shown) indicates a user-defined frequency synced from receiver and it only can be changed via PC.

IV. MUTE setting

1. Press MUTE button to enter MUTE mode.
2. Press MODE, SET buttons to access parameters. Returns to mute mode when button is not pressed for 5 seconds.
3. Press MUTE button to disable MUTE mode.
4. UNMUTE displays for 1 second and then returns to main screen.
5. MUTE button acts only under MANUAL setting.

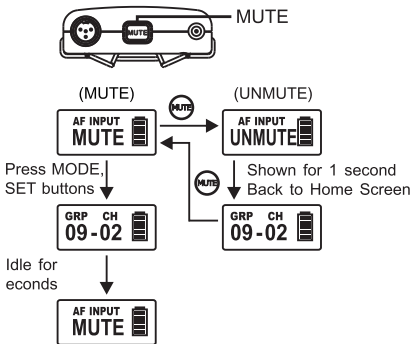

6. Remote Control Mute Connector:

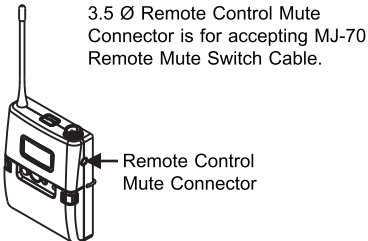

7. Remote Mute Switch (Optional): Plug MJ-70 Remote Mute Switch into Remote Control Mute Connector  before power on.

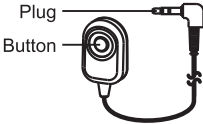

V. AA Battery Insertion and Replacement

1. Press the side hooks to open battery compartment. Remove the battery carefully.
2. Insert two AA sized batteries according to correct polarity.
3. Power off to conserve battery power. Remove the battery when it will not be used for extended periods of time.

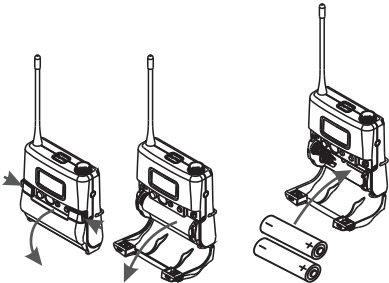

VI. Rechargeable Battery Insertion and Replacement

1. Press the side hooks to open battery compartment. Remove the battery carefully.
2. Insert one 18500 type lithium battery according to correct polarity.

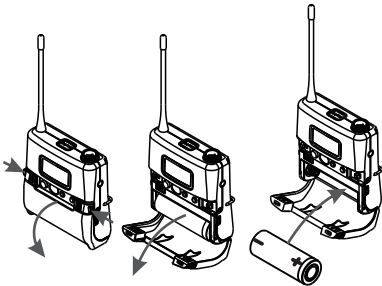

3. Check battery polarity was inserted correctly if battery power is sufficient but unable to turn on the transmitter. Battery protection circuit is activated if correct battery polarity. Below methods are available to bypass the battery circuit protection:
 - (A) Insert the transmitter into the single or dual-docking battery charger for at least 10 seconds. Power on the transmitter.
 - (B) Insert battery with incorrect polarity first. Remove and re-insert again with correct polarity.
 - (C) ACT-70TC/ACT-52TC/ACT-32TC: Open battery compartment, press the battery protection circuit button . Power on the transmitter.

Battery protection
circuit reset button

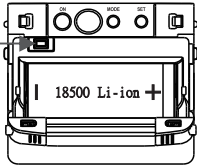

- (D) Power off to conserve battery power. Remove the battery when it will not be used for extended periods of time.
- (E) We recommend transmitter to be recharged directly in the docking battery charger.

VII. Transmitter Battery Chargers (optional)

Transmitter(s) can be inserted into MP-8 single-docking or dual-docking battery chargers.



Bodypack transmitter
recharged in MP-8

VIII. Notes

1. Refer to the actual product in the event of product description discrepancy.
2. Frequency range and maximum deviation comply with the regulations of different countries.
3. Spraying alcohol directly onto the condenser capsule module will cause severe damage and invalidate the warranty.

IX. 4-Pin Microphone Input Jack Wiring



1. 2-wire electret condenser microphone capsule connection:

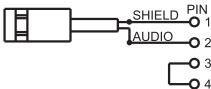

2. 3-wire electret condenser microphone capsule connection:

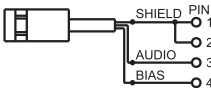

3. Dynamic Microphone:

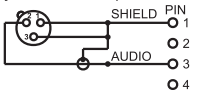

4. Electric Guitar:

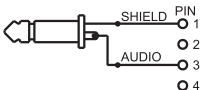

5. Line-input (impedance 8K ATT 10dB):



FCC

FCC Caution: To assure continued compliance, any changes or modifications not expressly approved by the party responsible for compliance could void the user's authority to operate this equipment. (Example - use only shielded interface cables when connecting to computer or peripheral devices).

This device complies with Part 15 of the FCC Rules. Operation is subject to the following two conditions:

- (1) This device may not cause harmful interference, and
- (2) This device must accept any interference received, including interference that may cause undesired operation.

This device complied with FCC radiation exposure limits as set forth for an uncontrolled environment. This device should be installed and operated so that its antenna(s) are not co-located or operating in conjunction with any other antenna or transmitter.

IC

This device complies with Industry Canada's RSSs. Operation is subject to the following two conditions:

- (1) This device may not cause interference; and
- (2) This device must accept any interference, including interference that may cause undesired operation of the device.

Le présent appareil est conforme aux CNR d'Industrie Canada applicables aux appareils radio. L'exploitation est autorisée aux deux conditions suivantes :

- (1) l'appareil ne doit pas produire de brouillage;
- (2) l'utilisateur de l'appareil doit accepter tout brouillage radioélectrique subi, même si le brouillage est susceptible d'en compromettre le fonctionnement.

Federal Communication Commission Interference Statement

This equipment has been tested and found to comply with the limits for a Class B digital device, pursuant to Part 15 of the FCC Rules. These limits are designed to provide reasonable protection against harmful interference in a residential installation.

This equipment generates, uses and can radiate radio frequency energy and, if not installed and used in accordance with the instructions, may cause harmful interference to radio communications. However, there is no guarantee that interference will not occur in a particular installation. If this equipment does cause harmful interference to radio or television reception, which can be determined by turning the equipment off and on, the user is encouraged to try to correct the interference by one of the following measures:

- Reorient or relocate the receiving antenna.
- Increase the separation between the equipment and receiver.
- Connect the equipment into an outlet on a circuit different from that to which the receiver is connected.
- Consult the dealer or an experienced radio/TV technician for help.

FCC Caution: To assure continued compliance, any changes or modifications not expressly approved by the party responsible for compliance could void the user's authority to operate this equipment. (Example - use only shielded interface cables when connecting to computer or peripheral devices).

FCC Radiation Exposure Statement

This equipment complies with FCC RF radiation exposure limits set forth for an uncontrolled environment.

This transmitter must not be co-located or operating in conjunction with any other antenna or transmitter.

This device complies with Part 15 of the FCC Rules. Operation is subject to the following two conditions:

- (1) This device may not cause harmful interference, and
- (2) This device must accept any interference received, including interference that may cause undesired operation.

Industry Canada Statement

This device complies with Industry Canada licence-exempt RSS standard.

Operation is subject to the following two conditions:

- (1) this device may not cause interference, and
- (2) this device must accept any interference, including interference that may cause undesired operation of the device.

Le présent appareil est conforme aux CNR d'Industrie Canada applicables aux appareils radio exempts de licence.

L'exploitation est autorisée aux deux conditions suivantes :

- (1) l'appareil ne doit pas produire de brouillage, et (2) l'utilisateur de l'appareil doit accepter tout brouillage radioélectrique subi, même si le brouillage est susceptible d'en compromettre le fonctionnement.

IC Radiation Exposure Statement:

This equipment complies with IC RSS-102 radiation exposure limit set forth for an uncontrolled environment.

Cet équipement est conforme aux CNR-102 d'Industrie Canada.

MIPRO[®]
MICROPHONE PROFESSIONALS



All rights reserved. Do not copy or forward without prior approvals of MIPRO. Specifications and design subject to change without notice. YM 022/02

MIPRO Electronics Co., Ltd

Headquarters: No. 814, Beigang Rd., Chiayi City 600079, Taiwan
Tel : +886.5.238.0809 Fax : +886.5.238.0803
www.mipro.com.tw mipro@mipro.com.tw



2 CE6 12 E